



Ortho CAPE

FOOT SURGERY

Pour toute question concernant nos produits,
contactez-nous sur info@ortho-cape.com

NOS FRAISES PERCUTANÉES

OrthoCAPE

- Fraises en acier X90CrMoV18
- Chirurgie percutanée
- Conditionnement unitaire stérile
- Fraises standards Ø 2.32 Lg 70 mm



	N°	RÉF.	Ø	LG DE COUPE	LG FRAISE
SHANNON COURTE	①	38.37.01	2 MM	8 MM	70 MM
SHANNON LONGUE	②	38.37.02	2 MM	12 MM	70 MM
SHANNON ISHAM	③	38.37.03	2 MM	12 MM	70 MM
SHANNON XL	④	38.37.07	2 MM	22 MM	70 MM
SHANNON XXL	⑤	38.37.08	3 MM	20 MM	70 MM
SHANNON XXL LG 30	⑥	38.37.09	3 MM	30 MM	100 MM
BROPHY	⑦	38.37.06	5 MM	15 MM	70 MM
BROPHY COURTE	⑧	38.37.0X	5 MM	13 MM	70 MM
BROPHY SLIM	⑨	38.37.0X	4 MM	13 MM	70 MM
WEDGE Ø3,1	⑩	38.37.04	3,1 MM	13 MM	70 MM
WEDGE Ø4,1	⑪	38.37.05	4,1 MM	13 MM	70 MM
CONIQUE	⑫	38.37.20	3,1 MM	13 MM	70 MM
BOULE Ø4,0	⑬	38.37.XX	4 MM	3 MM	70 MM
BOULE Ø5,0	⑭	38.37.XX	5 MM	4 MM	70 MM

bientôt disponible

bientôt disponible

bientôt disponible

bientôt disponible

NOS INSTRUMENTS PERCUTANÉS

OrthoCAPE



ANCILLAIRE

N°	PRODUIT	RÉF.
1	Elévateur	31.33.02
2	Levier à os	31.33.03
3	Râpe à os	31.33.01
4	Porte lame Beaver 15.5cm	6061
5	Lames de bistouri Beaver (boite de 25) SM64	5904
6	Boite de rangement	14.10.99

NOTRE GAMME DE VIS

OrthoCAPE

SCREWDRIVER

Ø2.0 Ø2.5



Ø 3.0 Ø 4.0

MI SCREW

Ø2.5 Ø4.0



Ø 4.6 Ø 7.0

EAGLE

Ø2.5 Ø4.0

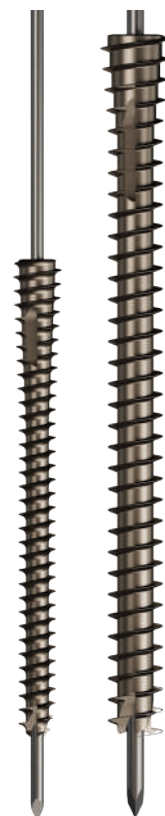

Ø 4.6 Ø 7.0

ARTHROSTAB

SCREWDRIVER

Ø2.0



Ø 2.0

MISS

Ø2.0



Ø2.0

SBS

Torx T7



Ø 2.5

MY SCREW

Ø2.0



Ø 2.6

PPDA

Ø2.0



Ø 3.0

NOS RÉFÉRENCES

OrthoCAPE

VIS				
NOM.	Ø	LONG.		RÉF.
MI SCREW Ø3	3.0	18 à 60 MM		38.92.xx
MI SCREW Ø4	4.0	32 à 60 MM		38.23.xx
EAGLE Ø4.6	4.6	20 à 60 MM		38.98.xx
EAGLE Ø7.0	7.0	30 à 90 MM	FILETAGE 16	38.99.xxA
EAGLE Ø7.0	7.0	55 à 90 MM	FILETAGE 22	38.99.xxB
EAGLE Ø7.0	7.0	70 à 90 MM	FILETAGE 28	38.99.xxC
ARTHROSTAB Ø4.6	4.6	20 à 60 MM		38.21.xx
ARTHROSTAB Ø7.0	7.0	30 à 90 MM		38.22.xx
MISS	2.0	13 à 22 MM		38.52.xx
SBS	2.0	09 à 24 MM		14.52.xx
MY SCREW	2.5	12 à 34 MM		38.88.xx
PPDA Ø2.6	2.6	12 à 34 MM		38.49.xx
PPDA Ø3.0	3.0	12 à 34 MM		38.65.xx
BROCHE	0.8	70 MM		14.63.41
BROCHE	1.0	70 MM		14.63.01
BROCHE	1.0	150 MM	1 PTE TROCART	14.63.48
BROCHE	1.50	150 MM	1 PTE TROCART	14.63.44
BROCHE	2.2	200 MM	1 PTE TROCART	14.63.10

MI SCREW

Ø 3.0 MM Ø 4.0 MM

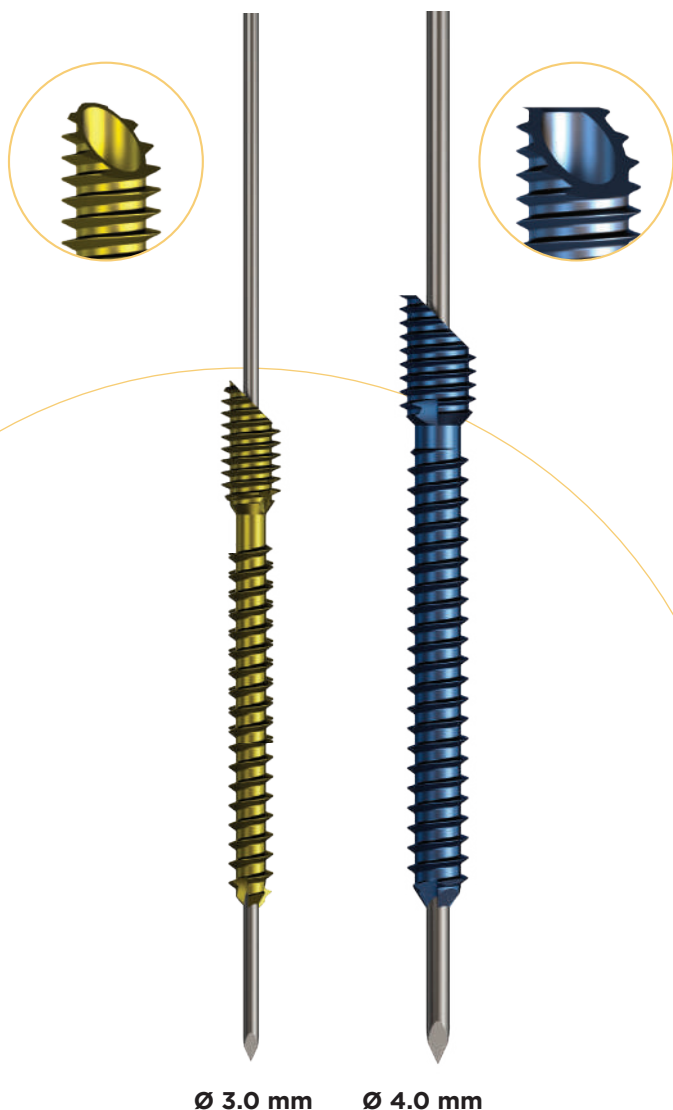

- Vis titane ISO 5832-3
- Autoforeuse et auto-taraudeuse
- Avant-pied
- Conditionnement stérile
- Broche Ø 1.0 pour vis Ø 3.0 mm
Broche Ø 1.5 pour vis Ø 4.0 mm

	Ø 3.0	Ø 4.0
LONG.	RÉF.	RÉF.
18	38.92.18	
20	38.92.20	
22	38.92.22	
24	38.92.24	
26	38.92.26	
28	38.92.28	
30	38.92.30	
32	38.92.32	38.23.32
34	38.92.34	38.23.34
36	38.92.36	38.23.36
38	38.92.38	38.23.38
40	38.92.40	38.23.40
42	38.92.42	38.23.42
44	38.92.44	38.23.44
46	38.92.46	38.23.46
48	38.92.48	38.23.48
50	38.92.50	38.23.50
52	38.92.52	38.23.52
54	38.92.54	38.23.54
56	38.92.56	38.23.56
58	38.92.58	38.23.58
60	38.92.60	38.23.60

ANCILLAIRE

N°	PRODUIT	RÉF.
1	Forêt tête pour vis Ø 4.0	14.37.21
2	Tournevis (lame) canulé Mi Screw Ø 4.0	14.30.10
3	Forêt pour vis Ø 4.0	14.37.33
4	Manche de tournevis AO universel	14.32.03
5	Broches Ø 1.50 Lg 150 mm 1 pointe trocart	14.63.44
6	Tournevis (lame) canulé pour vis Ø 3.0	14.30.23B
7	Forêt pour vis Ø 3.0	14.37.24B
8	Mesureur sur broche 150 mm	14.33.33
9	Forêt tête pour vis Ø 3.0	14.37.20
10	Broches Ø 1.0 Lg 150 mm 1 pointe trocart	14.63.48
11	Boite de rangement	14.10.01

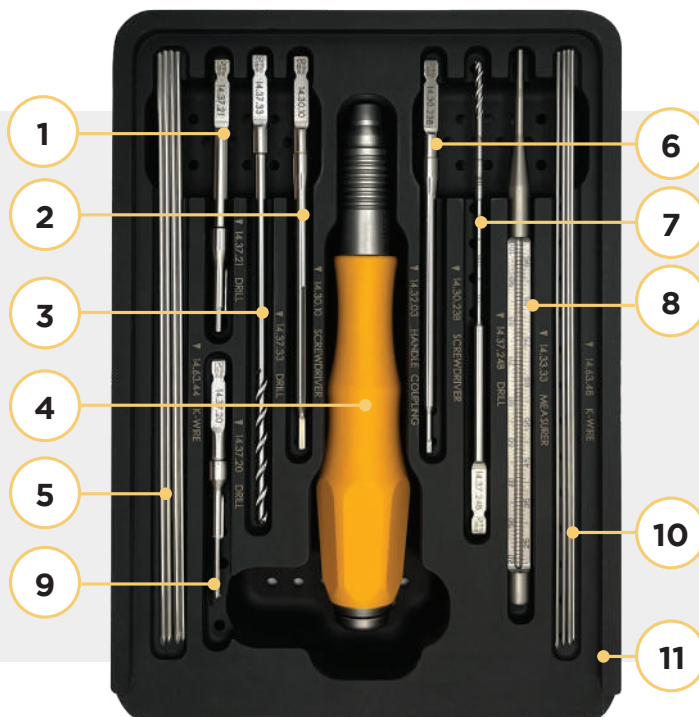

EAGLE

Ø 4.6 MM Ø 7.0 MM

- Vis titane ISO 5832-3
- Medio et arrière-pied
- Conditionnement stérile
- Broche Ø 1.5 pour vis Ø 4.6 mm
Broche Ø 2.2 pour vis Ø 7.0 mm

Tête Ø 6.0 mm



Tête Ø 9.5 mm

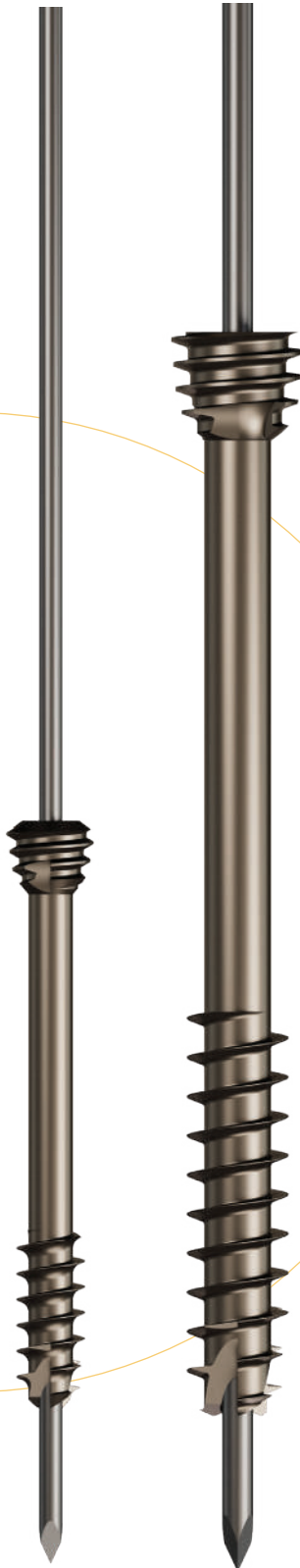

Ø 4.6 mm

Ø 7.0 mm

Ø 4.6 mm

LONG.	RÉF.
20	38.98.20
22	38.98.22
24	38.98.24
26	38.98.26
28	38.98.28
30	38.98.30
32	38.98.32
34	38.98.34
36	38.98.36
38	38.98.38
40	38.98.40
42	38.98.42
44	38.98.44
46	38.98.46
48	38.98.48
50	38.98.50
52	38.98.52
54	38.98.54
56	38.98.56
58	38.98.58
60	38.98.60

Ø 7.0 mm

LONG.	RÉF.	LONG.	RÉF.	LONG.	RÉF.
FILETAGE 16 MM		FILETAGE 22 MM		FILETAGE 28 MM	
30	38.99.30A				
35	38.99.35A				
40	38.99.40A				
45	38.99.45A				
50	38.99.50A				
55	38.99.55A	55	38.99.55B		
60	38.99.60A	60	38.99.60B		
65	38.99.65A	65	38.99.65B		
70	38.99.70A	70	38.99.70B	70	38.99.70C
75	38.99.75A	75	38.99.75B	75	38.99.75C
80	38.99.80A	80	38.99.80B	80	38.99.80C
85	38.99.85A	85	38.99.85B	85	38.99.85C
90	38.99.90A	90	38.99.90B	90	38.99.90C

EAGLE - ARTHROSTAB

Ø 4.6 MM Ø 7.0 MM



Ø 4.6 MM

ANCILLAIRE

	PRODUIT	RÉF.
1	Manche de tournevis AO universel	14.32.03
2	Tournevis (lame) pour vis Ø 4.6	14.30.17
3	Forêt tête pour vis Ø 4.6	14.37.34
4	Taraud Eagle Arthrostab Ø 4.6	14.33.36
5	Forêt pour vis Ø 4.6	14.37.33
6	Mesureur sur broche 150 mm	14.33.33
7	Broches Ø 1.5 Lg 150 mm 1 pointe trocart	14.63.44
8	Boite de rangement	14.10.96

Les vis s'utilisent avec 1 broche Ø 1,5 lg 150 mm
1 pointe trocart

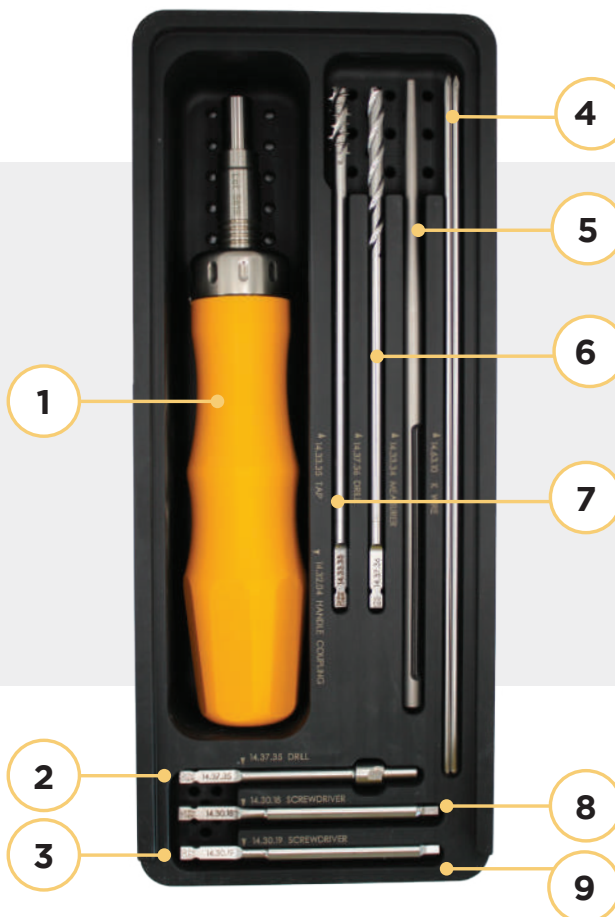

Ø 7.0 MM

ANCILLAIRE

	PRODUIT	RÉF.
1	Manche de tournevis Eagle Arthrostab Ø 7.0	14.32.04
2	Forêt tête pour vis Ø 7.0	14.37.35
3	Tournevis (lame) percé pour vis Ø 7.0	14.30.18
4	Broches Ø 2.2 Lg 200 mm 1 pointe trocart	14.63.10
5	Mesureur sur broche 200 mm	14.33.34
6	Forêt canulé pour vis Ø 7.0	14.37.36
7	Taraud Eagle Arthrostab Ø 7.0	14.33.35
8	Tournevis (lame) pour vis Ø 7.0	14.30.19
9	Boite de rangement	14.10.97

Les vis s'utilisent avec 1 broche Ø 2,2 lg 200 mm
1 pointe trocart

ARTHROSTAB

Ø 4.6 MM Ø 7.0 MM

Tête Ø 6.0 mm



Tête Ø 9.0 mm

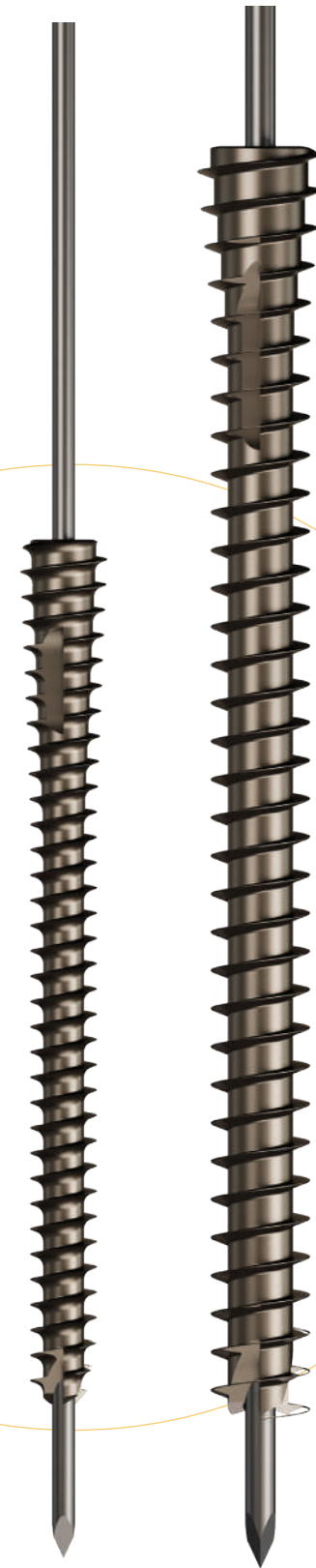

Ø 4.6 mm

Ø 7.0 mm

- Vis titane ISO 5832-3
- Medio et arrière-pied
- Conditionnement stérile
- Broche Ø 1.5 pour vis Ø 4.6 mm
Broche Ø 2.2 pour vis Ø 7.0 mm

Ø 4.6 mm

LONG.	RÉF.
20	38.21.20
22	38.21.22
24	38.21.24
26	38.21.26
28	38.21.28
30	38.21.30
32	38.21.32
34	38.21.34
36	38.21.36
38	38.21.38
40	38.21.40
42	38.21.42
44	38.21.44
46	38.21.46
48	38.21.48
50	38.21.50
52	38.21.52
54	38.21.54
56	38.21.56
58	38.21.58
60	38.21.60

Ø 7.0 mm

LONG.	RÉF.
30	38.22.30
35	38.22.35
40	38.22.40
45	38.22.45
50	38.22.50
55	38.22.55
60	38.22.60
65	38.22.65
70	38.22.70
75	38.22.75
80	38.22.80
85	38.22.85
90	38.22.90

EAGLE - ARTHROSTAB

Ø 4.6 MM Ø 7.0 MM



Ø 4.6 MM

ANCILLAIRE

	PRODUIT	RÉF.
1	Manche de tournevis AO universel	14.32.03
2	Tournevis (lame) pour vis Ø 4.6	14.30.17
3	Forêt tête pour vis Ø 4.6	14.37.34
4	Taraud Eagle Arthrostab Ø 4.6	14.33.36
5	Forêt pour vis Ø 4.6	14.37.33
6	Mesureur sur broche 150 mm	14.33.33
7	Broches Ø 1.5 Lg 150 mm 1 pointe trocart	14.63.44
8	Boite de rangement	14.10.96

Les vis s'utilisent avec 1 broche Ø 1,5 lg 150 mm
1 pointe trocart

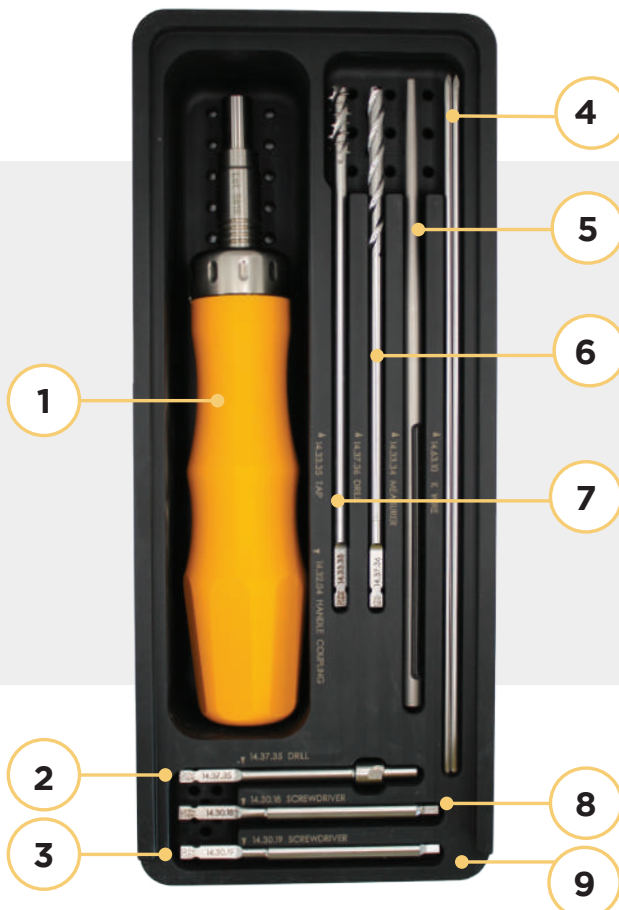

Ø 7.0 MM

ANCILLAIRE

	PRODUIT	RÉF.
1	Manche de tournevis Eagle Arthrostab Ø 7.0	14.32.04
2	Forêt tête pour vis Ø 7.0	14.37.35
3	Tournevis (lame) percé pour vis Ø 7.0	14.30.18
4	Broches Ø 2.2 Lg 200 mm 1 pointe trocart	14.63.10
5	Mesureur sur broche 200 mm	14.33.34
6	Forêt canulé pour vis Ø 7.0	14.37.36
7	Taraud Eagle Arthrostab Ø 7.0	14.33.35
8	Tournevis (lame) pour vis Ø 7.0	14.30.19
9	Boite de rangement	14.10.97

Les vis s'utilisent avec 1 broche Ø 2,2 lg 200 mm
1 pointe trocart

MISS

Ø 2.0 MM

- Vis en titane ISO 5832-3
- Sécable, auto perforante et auto taraudeuse
- Avant-pied
- Conditionnement stérile



Ø 2.0 mm

Ø 2.0	
LONG.	RÉF.
13	38.52.13
15	38.52.15
17	38.52.17
19	38.52.19
22	38.52.22

ANCILLAIRE

N°	PRODUIT	RÉF.
1	Pointe carré pour vis MISS	14.33.25
2	Lame AO pour vis MISS	14.30.12
3	Manche de Tournevis AO	14.32.03



1

Pointe carrée pour vis MISS

14.33.25

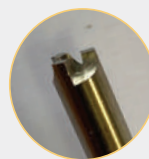

2

Lame AO pour vis MISS

14.30.12



3

Manche de tournevis AO

SBS

Ø 2.0

- Vis en titane ISO 5832-3
- Sécable, auto perforante et auto taraudeuse
- Avant-pied
- Conditionnement stérile



Ø 2.0mm

Ø 2.0 mm	
LONG.	RÉF.
05	14.52.05
06	14.52.06
07	14.52.07
08	14.52.08
09	14.52.09
10	14.52.10
11	14.52.11
12	14.52.12
13	14.52.13
14	14.52.14
15	14.52.15
16	14.52.16
17	14.52.17
18	14.52.18
19	14.52.19
20	14.52.20
21	14.52.21
22	14.52.22
23	14.52.23
24	14.52.24

ANCILLAIRE

N°	PRODUIT	RÉF.
1	Lame de tournevis SBS	14.30.02
2	Manche de Tournevis AO	14.32.03



MY SCREW

Ø 2.5 MM



Ø 2.5 mm

Tête Ø 3.5 mm



- Vis en titane ISO 5832-3
- Auto taraudeuse, auto foreuse et auto compressive
- Avant-pied
- Conditionnement stérile
- Broche Ø 1.0 pour vis Ø 2.5 mm

Ø 2.5 mm	
LONG.	RÉF.
12	38.88.12
14	38.88.14
16	38.88.16
18	38.88.18
20	38.88.20
22	38.88.22
24	38.88.24
26	38.88.26
28	38.88.28
30	38.88.30
32	38.88.32
34	38.88.34

ANCILLAIRE

N°	PRODUIT	RÉF.
1	Forêt canulé pour vis My Screw Ø2.5	14.37.25
2	Forêt canulé pour vis My Screw Ø2.5 XS	14.37.27
3	Mesureur sur broche 70 mm	14.33.22
4	Tournevis (lame) Torx 7	14.30.22
5	Tournevis (lame) Torx 7 canulé	14.30.21
6	Broches Ø 1.0 Lg 70 mm	14.63.01
7	Manche de tournevis AO universel	14.32.03
8	Boite de rangement	14.10.88

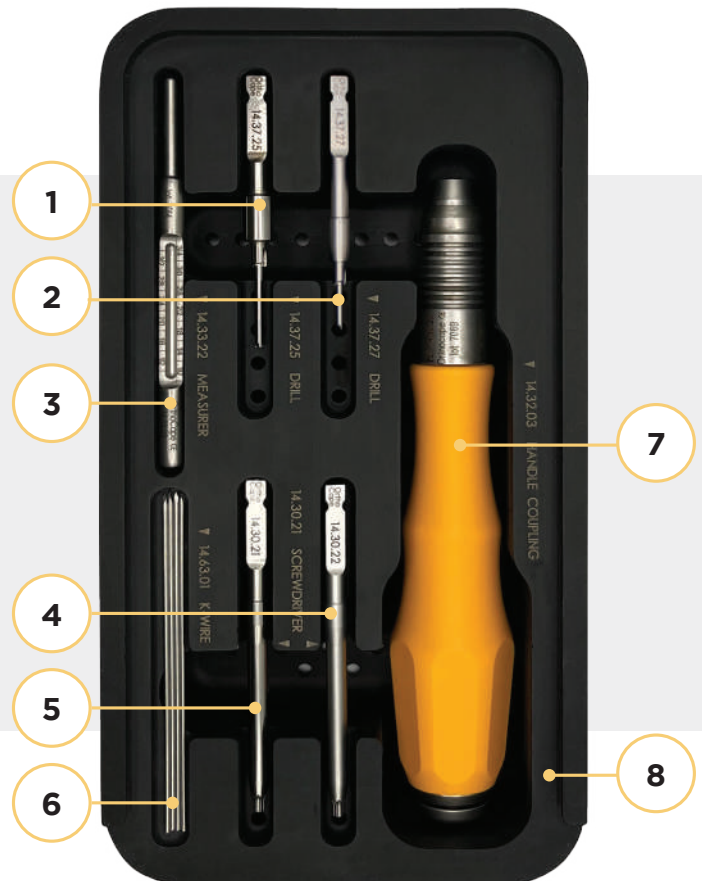

PPDA

Ø 2.6 MM Ø 3.0 MM

Tête Ø 3.6 mm

Tête Ø 4.0 mm

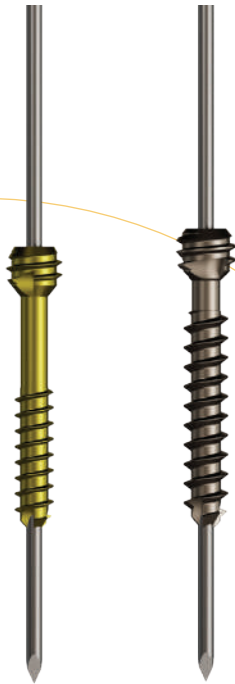

Ø 2.6 mm Ø 3.0 mm

- Vis en Titane ISO 5832-3
- Auto foreuse, perforée, pas différents, auto compressive
- Avant-pied
- Conditionnement stérile
- Broche Ø1.0 pour vis Ø 2.6 et Ø 3.0mm

Ø 2.6 mm		Ø 3.0 mm	
LONG.	RÉF.	LONG.	RÉF.
12	38.49.12	12	38.65.12
14	38.49.14	14	38.65.14
16	38.49.16	16	38.65.16
18	38.49.18	18	38.65.18
20	38.49.20	20	38.65.20
22	38.49.22	22	38.65.22
24	38.49.24	24	38.65.24
26	38.49.26	26	38.65.26
28	38.49.28	28	38.65.28
30	38.49.30	30	38.65.30
32	38.49.32	32	38.65.32
34	38.49.34	34	38.65.34

ANCILLAIRE

N°	PRODUIT	RÉF.
1	Forêt canulé pour vis PPDA Ø 2.6	14.37.25
2	Forêt canulé XS pour vis PPDA Ø 2.6	14.37.27
3	Mesureur sur broche 70 mm	14.33.22
4	Forêt canulé pour vis PPDA Ø 3.0	14.37.23
5	Lame de tournevis pour vis Ø2.6 et Ø3.0	14.30.23
6	Broches Ø 1.0 Lg 70 mm	14.63.01
7	Manche de tournevis AO universel	14.32.03
8	Boîte de rangement	14.10.88

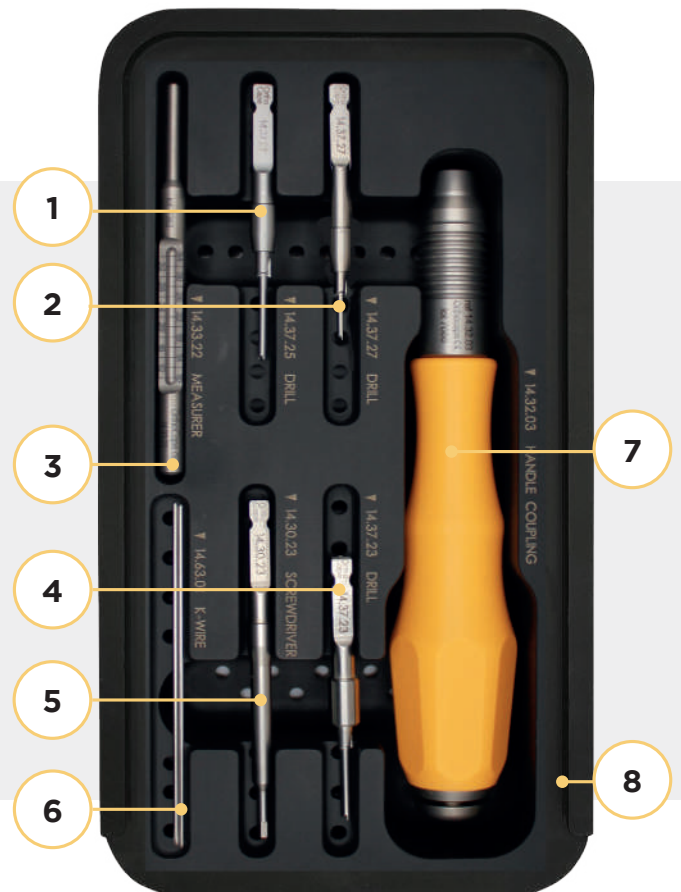

NOS AGRAFES DE VARISATION

ANGLE 26° OU 90°

- Agrafes en inox 316L ISO 5832-1
- Conditionnement stérile
- Pour ostéotomies AKIN

	ANGLE 26°	ANGLE 90°
Écartement 8 mm	14.55.04	14.55.02
Écartement 10 mm	14.55.03	14.55.01

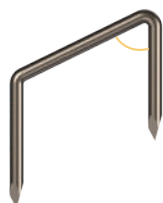

ANGLE 26°



ANGLE 90°

ANCILLAIRE

N°	PRODUIT	RÉF.
1	Guide de perçage	14.33.55
2	Positionneur 26°	14.33.52
3	Impacteur 26°	14.33.54
4	Positionneur 90°	14.33.51
5	Impacteur 90°	14.33.53
6	Boîte de rangement	14.10.50

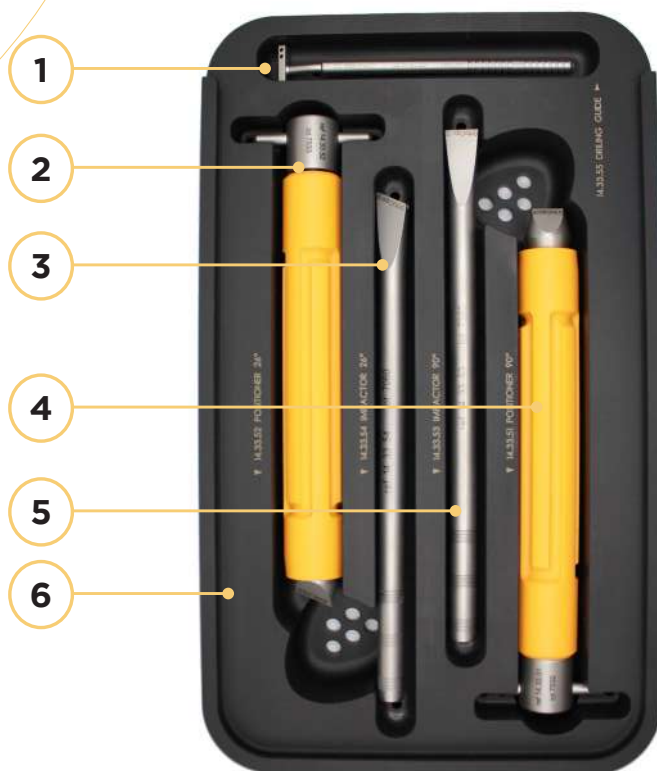

NOS BROCHES À BILLE

LONGUEUR 150 MM

- Inox 316L répondant à la norme ISO 5832-1
- Extrémités triangulaires
- Conditionnement à l'unité stérile broche + embout



**BROCHE FILETÉE
ET EMBOUT ANTI-MIGRATION**

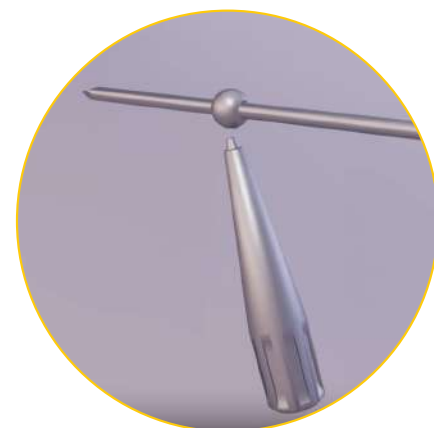

Longueur 150 mm

DIAMÈTRE	RÉF.
broche filetée Ø 1.0 mm + embout antimigration	38.63.13/18
broche filetée Ø 1.2 mm + embout antimigration	38.63.14/18
broche filetée Ø 1.5 mm + embout antimigration	38.63.15/19
broche filetée Ø 1.8 mm + embout antimigration	38.63.16/20
broche filetée Ø 2.0 mm + embout antimigration	38.63.17/20

JACK-S SCREW

6 TAILLES



- Vis titane
- Vis sous-talienne pour repositionnement calcanéen.
- Insertion facile / Parfaite stabilité
- Traitement du pied plat chez l'adulte et l'enfant

REF	Ø	LONG.
42-0712	7.0	12
42-0814	8.0	14
42-0914	9.0	14
42-1014	10.0	14
42-1116	11.0	16
42-1216	12.0	16

ANCILLAIRE

REF	PRODUIT
ML-2000	Boite de rangement
ML-1007	Mesureur fileté Ø 7.0
ML-1008	Mesureur fileté Ø 8.0
ML-1009	Mesureur fileté Ø 9.0
ML-1010	Mesureur fileté Ø 10.0
ML-1011	Mesureur fileté Ø 11.0
ML-1012	Mesureur fileté Ø 12.0
42-4230	Lame de tournevis
42-4220	Extracteur
42-4240	Sonde
14.63.18	Broche Ø 1.8 Lg2 00
42-4243	Dilatateur
55-2951	Manche de tournevis



HAMMERFIX

3 TAILLES

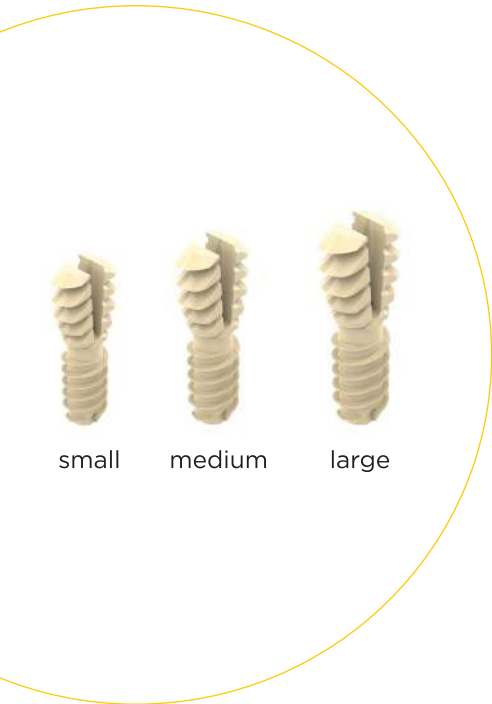

small medium large

- Zeniva® PEEK
- Segment à ergots de l'implant conçu pour se déployer dans la phalange proximale
- Filetages opposés permettant une compression supplémentaire à travers l'articulation
- S'adapte aux variations de taille des phalanges

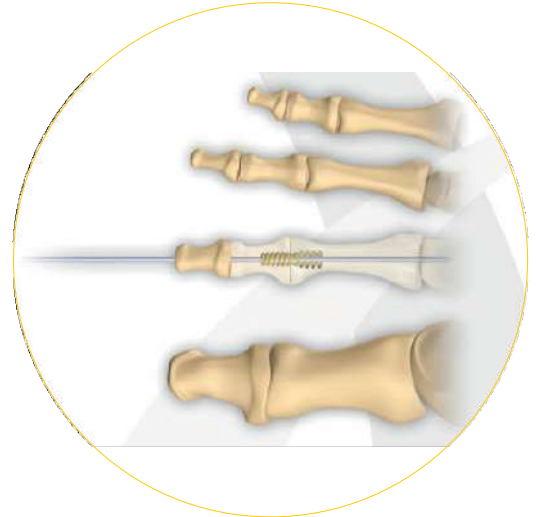

	S	M	L
TAILLE	2.8	3.4	4.0
LONGUEUR TOTALE	13.5	15.0	15.0
Ø MAX DE LA VIS	2.8	3.4	4.0
Ø MAX DE L'ERGOT	4.0	4.5	5.5
LONGUEUR PROXIMALE DE L'ERGOT	5.5	6.8	6.8
LONGUEUR FILETÉE MÉDIANE	6.5	7.0	7.0

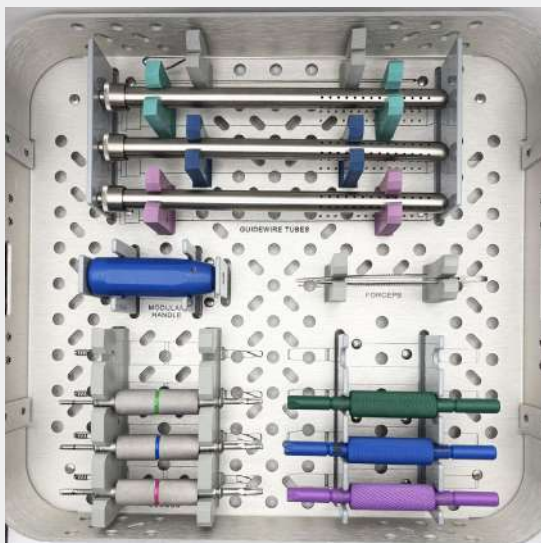

ANCILLAIRE	
REF	PRODUIT
132-00100	Boîte de rangement
	Tige de nettoyage
132-00211	Tube à broches S Ø1.1
132-00214	Tube à broches M Ø1.4
132-00216	Tube à broches L Ø1.6
132-00004	Manche de tournevis
132-00005	Pince
132-00028	Taraud/Foret S
132-00034	Taraud/Foret M
132-00040	Taraud/Foret L
132-00001	Tournevis S
132-00002	Tournevis M
132-00003	Tournevis L

TENDON REPAIR

HS 530 - LPPR 8112402

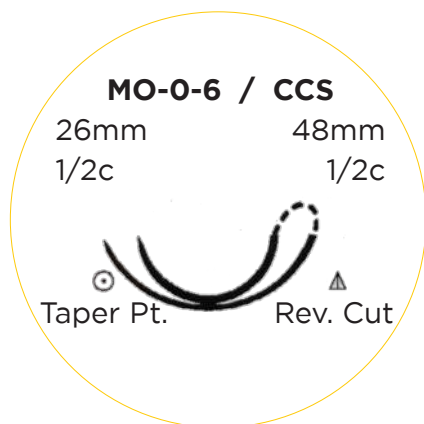

- USP 5 / EP 7
- Fil Ø 0.7
- Longueur : 90 cm
- Couleur : blanc & vert
- Aiguilles 1/2c 26 mm et 1/2c 48 mm
- Sutures non resorbables UHMWPE
- Sutures doubles aiguilles

GENOUX / CHEVILLE / HANCHE



Très grande facilité
de serrage

UTILISATIONS

- Renfort et ré insertion ligamentaire, tendineux
- Suture et ancrage idéal sur genoux hanche et cheville

Télécharger le certificat CE



SHOULDER REPAIR FIBER TAPE

HS 1071 - LPPR 8112419

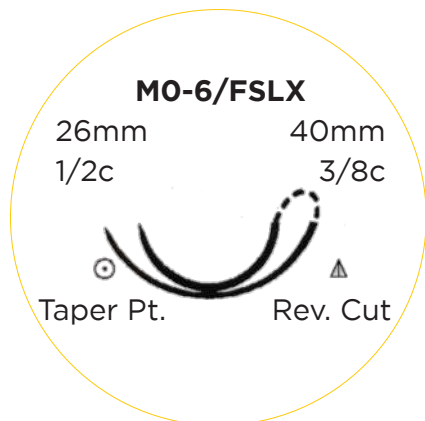

- USP 2 (EP 5) de 0.50mm - 0.599mm
- Ruban plat de 0.50 mm
- Longueur : 100 cm
- Couleur : bleu cobalt
- Aiguilles : 1/2 26 mm et 3/8 40 mm
- Sutures non résorbables UHMWPE
- Sutures doubles aiguilles

ÉPAULE



Suture de renfort sous forme de ruban plat

Permet une surface d'appui plus importante tout en limitant les risques de cisaillement.

LE FIL DE RÉFÉRENCE
POUR LA CHIRURGIE
DE L'ÉPAULE



UTILISATIONS

- Renfort ligamentaire
- Ancrage tendineux
- Reconstruction
- Rapprochement des tissus

Télécharger le certificat CE



SHOULDER AND ANKLE REPAIR FIBER TAPE

HS 1072 - LPPR 8112419

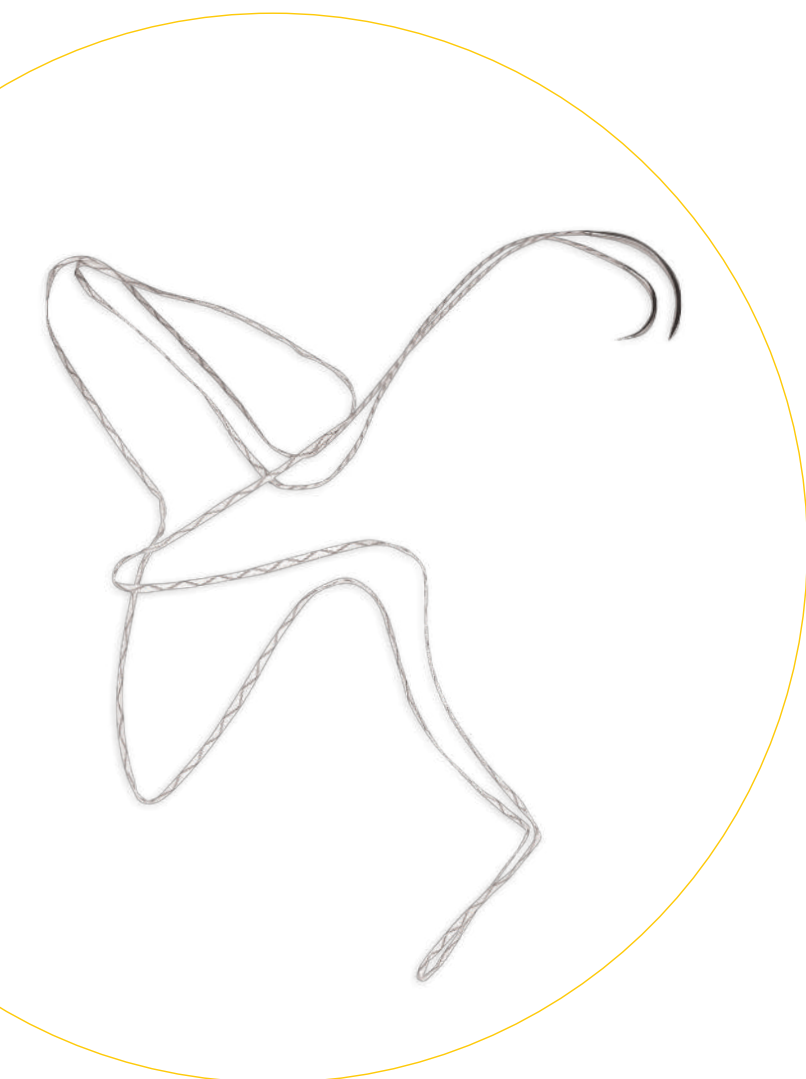
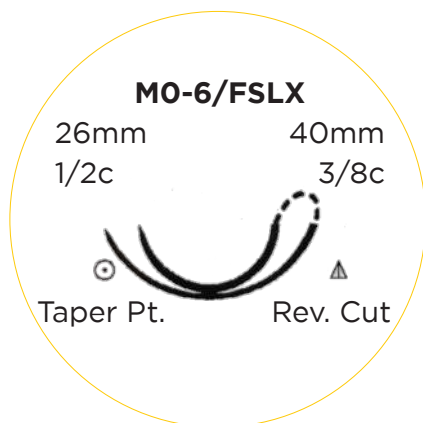

- USP 2 (EP 5) de 0.50mm - 0.599mm
- Ruban plat de 0.50 mm
- Longueur: 100 cm
- Couleur : bleu & blanc
- Aiguilles : 1/2 26 mm et 3/8 40 mm
- Sutures non résorbables UHMWPE
- Sutures doubles aiguilles

ÉPAULE / CHEVILLE



Suture de renfort sous forme de ruban plat

Permet une surface d'appui plus importante tout en limitant les risques de cisaillement.

Fil bi colore pour une meilleure visibilité sous arthroscopie.

UTILISATIONS

- Renfort ligamentaire
- Ancrage tendineux
- Reconstruction
- Rapprochement des tissus

Télécharger le certificat CE



CARTILAGINATOR

Flat
Single/Double Sided



Flat
Saw Tip

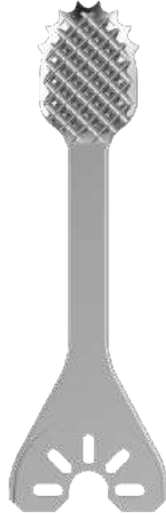

Large

Curved (3D)
Concave/Convex



Small

*Procedure Type	Flat Single-Sided	Flat Double-Sided	Large Curved Concave (3D)	Large Curved Convex (3D)	Small Curved Concave (3D)	Small Curved Convex (3D)	Flat Saw Tip
	168-05010	168-05020	170-01250	170-01251	170-02140	170-02141	170-00011
Ankle Fusion	✓	✓	✓	✓			✓
Charcot	✓	✓					✓
Double Arthrodesis	✓		✓	✓	✓	✓	
Lapidus	✓	✓					✓
Midfoot Fusion	✓	✓					✓
MTP Fusion	✓				✓	✓	
NC Fusion	✓	✓	✓	✓			
Subtalar Fusion	✓	✓	✓	✓			✓
Triple Arthrodesis	✓				✓	✓	✓



DT4 FIXATION SYSTEM

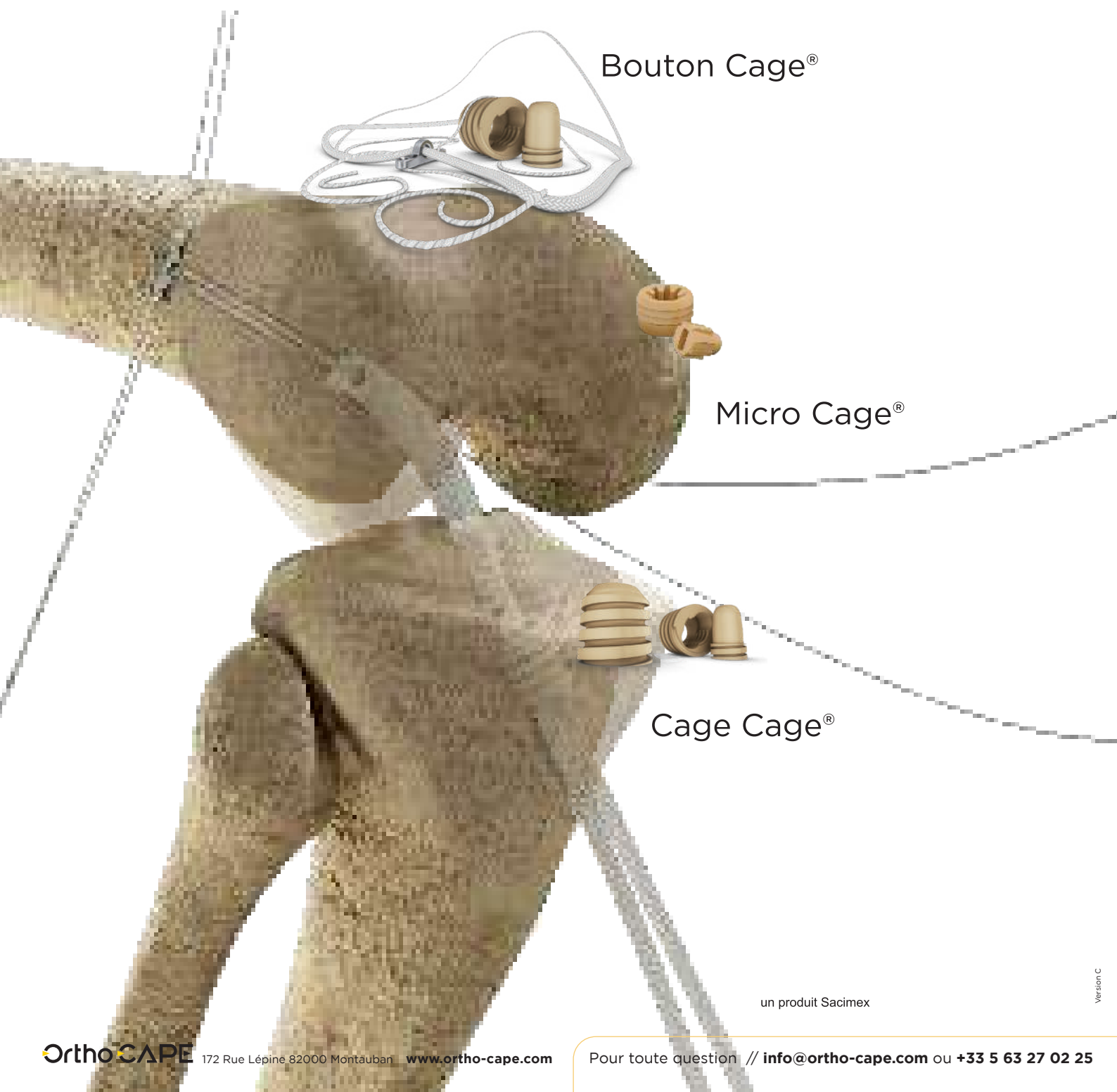

Bouton Cage®

Micro Cage®

Cage Cage®

un produit Sacimex



TÉL. +33 5 63 27 02 25



info@ortho-cape.com



172 rue Lépine 82000 Montauban
FRANCE

Télécharger le certificat CE



www.ortho-cape.com

IBAN FR76 1027 8022 0000 0210 4320 276 - BIC CMCIFR2A

N°TVA - FR 61 890810542

SIRET 890 810 542 00021 - APE 3250A